

These are oil-free rotary vane vacuum pumps, with a suction flow rate of 35 m³/h.

Characterized by a cover and flange with a graphite disc. The use of special graphite vanes reduces maintenance interventions and ensures clean air at the pump outlet.

The pump rotor and shaft are a single piece, supported by independent bearings mounted within the two pump end flanges. The pump and electric motor are thus two independent units, fixed to a dedicated support and connected to each other by an elastic coupling.

The RMS and RML series pumps are supplied with single-phase or three-phase electric motors (UL-CSA certified). Upon request, the pumps can be supplied with ATEX-certified motors, with special voltages and frequencies, or without motor.

The pump is cooled by a radial fan located between the motor and the pump.

On the pump discharge, a filter with silencing function is installed.

The BVS and RMS series pumps can also be used as compressors.

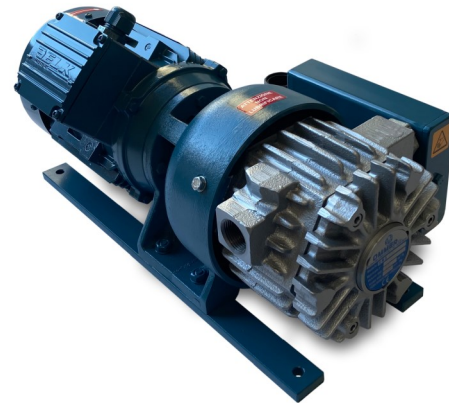

Use and installation

The use of these pumps is not recommended when the fluid to be aspirated contains vapors, water or oil condensates.

For the installation of OMMER vacuum pumps, it is sufficient to connect them to the vacuum circuit and set up the electrical connection to the motor.

Please ensure the correct rotation direction of the pump.

035RMS			
Frequency		50Hz	60Hz
Flow rate	m ³ /h	35	42
Ultimate pressure	mbar	90	
Motor performance	3~	230/400±5%	265/460±5%
Volt	1~	230±5%	
Motor power	3~	1,10	1,30
kW	1~	1,10	
Motor protection	IP	55	
Rotation speed	rpm	1450	1750
Motor shape		B14	
Motor size		90	
Weight	kg	37	

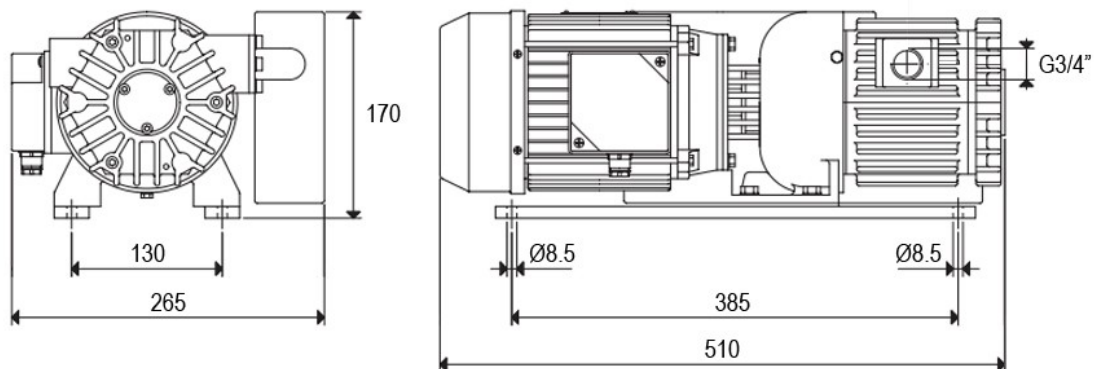

Data and dimensions are not mandatory. O.M.M.E.R. S.r.l. reserves the right to make changes and improvements at any time and without notice.

